

B0620



IMPERX: Technically superior products, full tech support, rapid-response customer care. "Bobcat 2.0" adds many new features, lens control, more memory and enhanced image quality. Each easy to use Bobcat is supported by IMPERX professionals.

INTERFACES AVAILABLE:

Resolution
 Sensor
 Sensor Format

Pixel Size
 Frame Rate Standard Clock
 Frame Rate Overclocked
 Maximum Frame Rate
 Minimum S/N Ratio
 Output Format

Analog Gain Control
 Black Level Control
 Digital Gain and Offset
 RGB Gain and Offset
 White Balance
 Shutter Speed
 Exposure Control
 Long Integration
 Regions of Interest (ROI)
 Binning H/V
 Trigger Inputs

Trigger Options

Trigger Modes

Double Trigger (PIV) Interframe
 External Inputs/Outputs
 Strobe Output
 RS232 Interface
 Pulse Generator
 Image Overlay
 Image Enhancement

Internal DDR Memory
 On Board FIFO (GEV & PoE)
 Gamma Correction
 Data Corrections

Min Illumination
 Lens Mount
 Video Iris Control
 Iris, Zoom Focus Control
 Supply Input Range
 Power Consumption
 Size – Width/Height
 Size – Length

Weight
 Vibration, Shock
 Environmental
 Humidity
 MTBF
 Regulatory

Camera Link® Base (PoCL), GigE Vision, PoE, CoaXPress

640 x 480 (std.), 648 x 488 (max.)
 KAI-0340D, CCD
 4.79mm (H) x 3.61 mm (V) 5.92mm diagonal
 1/3" optical format

7.40 μ m
 40 MHz / 207 fps
 50 MHz / 259 fps
 2101 fps
 60dB
 Mono CCD: 8, 10, 12, 14-bit (Single only)
 Color CCD: 8, 10, 12, RGB 24

Manual, Auto: 0 - 36dB 1024 steps
 Manual, 1024 steps

Manual
 Manual
 Manual, auto, off
 1us/step, 1/500,000 to 1/110 sec (nom)
 Manual, auto, external

Up to 16 seconds
 7 ROIs, any line to any line, any pixel to any pixel
 1x, 2x, 3x, 4x, 8x (Independent for H & V)
 External (TTL via IN1/IN2), pulse generator, software, computer

Level, edge, pulse width, internal exposure, up to 16 seconds trigger delay, debounce
 Free-run, standard, double, fast, asynchronous, frame accumulation

Time: 200 nanoseconds
 2 IN, 2 OUT, user programmable
 2 strobes, programmable position and duration
 Yes, programmable
 Yes, programmable
 Optical center, programmable H & V lines
 Threshold, contrast enhancement, knee correction, horizontal flip, negative image, bit shift (+/- 7 places)

2Gb (256 MB)
 1Gb (128 MB)
 G=1.0, G=0.45, user upgradeable LUT
 Defective/hot pixel correction (static, dynamic), black level, vertical smear

1 Lux, F/ 1.4
 C-Mount (Default), CS
 Auto, programmable

Manual, user programmable
 12VDC (10V - 15V), 1.5 A inrush
 CLB 3.3 W, GEV 4.6W, PoE 5.7W, CXP TBD
 46mm (W) x 46mm (H) – Applies to all interfaces
 CLB 46.8 mm (L), GEV 64.7mm (L), PoE 78.3mm (L), CXP 54.5mm (L)

CLB 160g, GEV 196g, PoE 298g, CXP 190g
 100g (20-200) HZ XYZ, 1000g
 -40°C to +85°C Operating, -50°C to +90°C Storage
 10% to 90% non-condensing
 >660,000 hours @ 40°C (Telcordia SR-332)
 FCC 15 part A, CE, RoHS

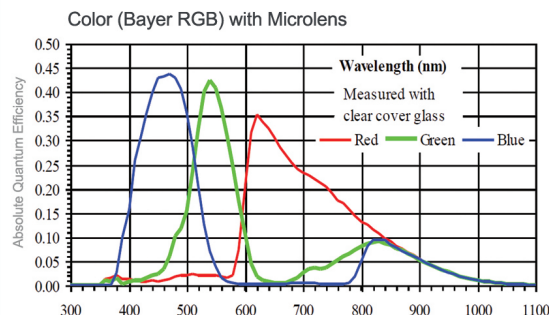
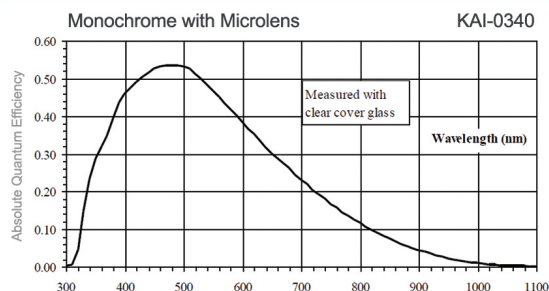

BOBCAT 2.0 B0620 Specifications

GigE Vision(Without PoE)

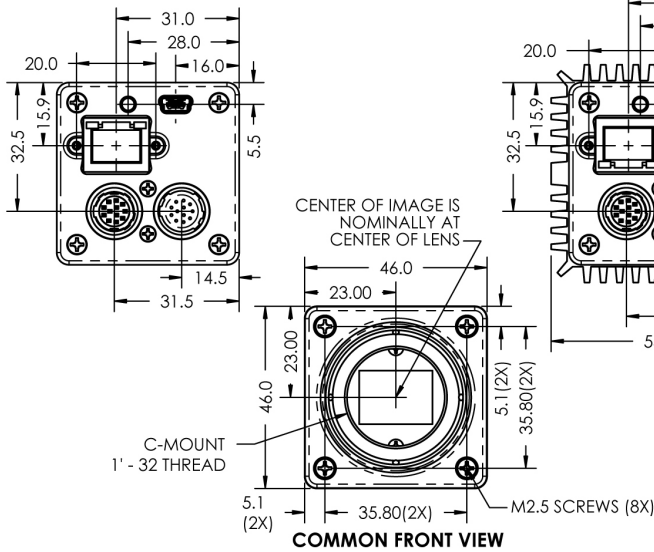
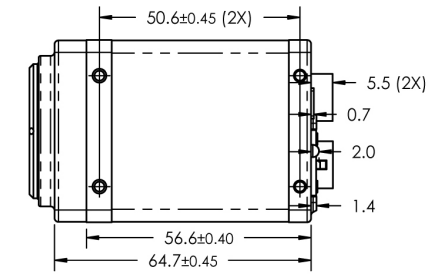

GigE Vision(With PoE)

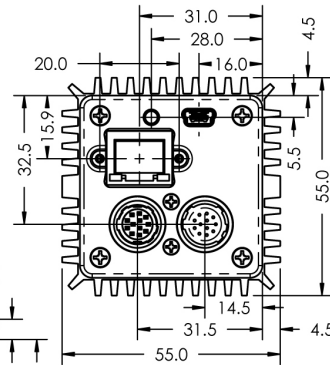
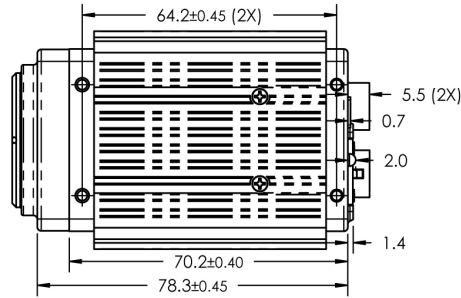

Camera Link

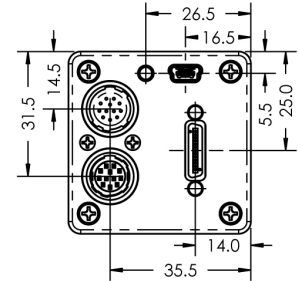
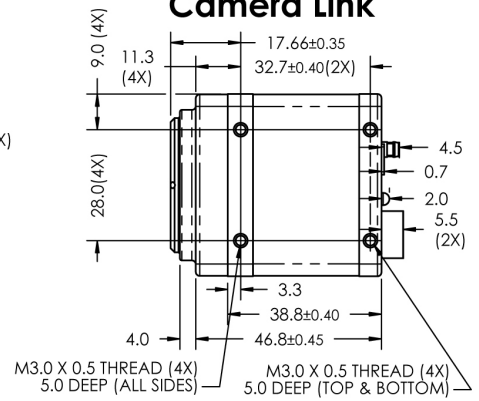

NOTE: DATUM "A" REFERS TO THE IMAGING PLANE (TOP OF IMAGING DIE)

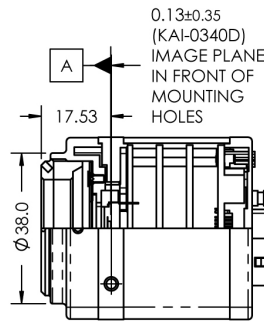

COMMON IMAGE PLANE DISTANCE

Hirose Connectors Power and I/O Interface

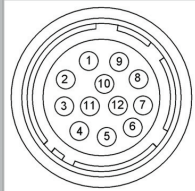

- | | |
|-------------------|-----------------|
| 1 12V DC Return * | 7 OUT1 Signal |
| 2 +12V DC* | 8 IN1 Signal |
| 3 IRIS VCC | 9 IN2 Signal |
| 4 IRIS Video | 10 IN1/2 Return |
| 5 IRIS Return | 11 Reserved |
| 6 OUT1/2 Return | 12 OUT2 Signal |

Connector: Hirose HR 10A- 10R- 12PB(71)
*Not connected for CXP

Lens Control/RS232

See manual for PIN information

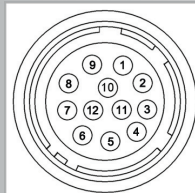

- | | |
|---------------|-------------|
| 1 IRIS Return | 7 FOCUS + |
| 2 IRIS VCC | 8 ZOOM - |
| 3 IRIS Video | 9 ZOOM + |
| 4 IRIS - | 10 UART_COM |
| 5 IRIS + | 11 UART_RX |
| 6 FOCUS - | 12 UART_TX |

Connector: Hirose HR 10A- 10R- 12SB(71)

CoaXPress

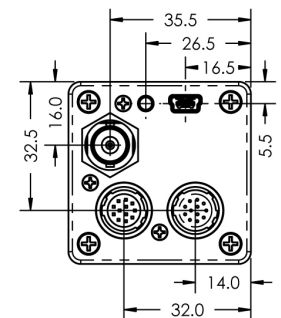
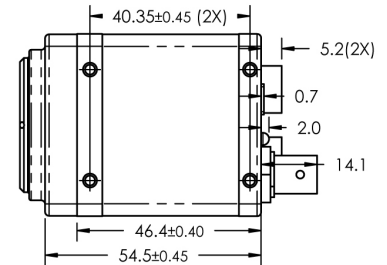

B0620 Ordering Information

Interfaces available

- Camera Link® Base (CLB)
- GigE Vision (GEV / PoE)
- CoaXPress (CXP)

Sensor types available

- Monochrome
- Bayer Color

Accessories (Sold separately)

- PS12v04-Power Supply w/ 1 input and 1 output
- PS12v05-Power Supply (as above) and Video Iris



WWW.IMPERX.COM



bobcat-B0620,Rev1